

PLAN VIEW

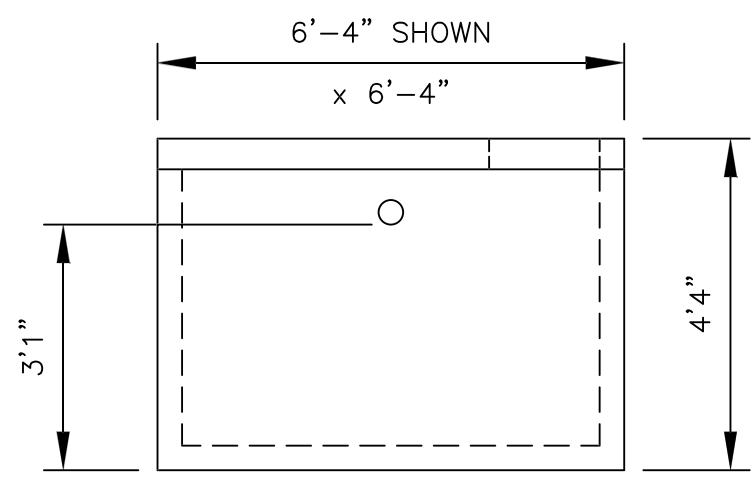

ELEVATION VIEW

- NOTES:
1. CONCRETE: 5,000 PSI MIN AFTER 28 DAYS.
 2. TYPE III CEMENT.
 3. TEST BAFFLES SOLD SEPARATELY.
 4. 4" POLYLOK IV CLOSED END BOOTS USED FOR CONNECTIONS.
 5. JOINT SEALED WITH BUTYLE RESIN.
 6. PUMPS & ACCESSORIES OPTIONAL
 7. PLASTIC RISER CAN BE POURED INTO COVER.

REV. NO.	DATE	REVISION

PREPARED BY:

DELTA
ENGINEERS, ARCHITECTS, & LAND SURVEYORS
184 COURT STREET, BINGHAMTON, NY 13901
TEL: (607) 231-6600 FAX: (607) 231-6650

PREPARED FOR:
ANDREW J. FOSS CO. INC.
100 COCHECO ROAD
FARMINGTON, NH 03835
PHONE(603)755-2515 FAX(603)278-7878

DATE: 9/18/09	SHEET TITLE: SKETCH	DRWN BY: GJP
SCALE: N.T.S.		CHK BY: KMK
PROJECT: 600 GALLON PUMP BOX 6'-4"x6'-4"x4'-6" H-20		
CONTRACTOR:	DWG. LD. SK-01	
DELTA PROJ. NO.: 2009.367.001	SHT. NO. 1 OF 1	